

HOLMAN

WX8

8 Station
Wi-Fi Irrigation
Controller



DOWNLOAD THE
LATEST MANUAL!

User Guide

Contents

Introduction	3
Key Features	3
Mobile Device System Requirements	3
Overview	4
Third Party Rain Sensors	4
Pump Connection	5
Setup	6
Initial Setup	6
Pairing Using EZ Mode	7
Pairing Using AP Mode	8
Status Screen	10
Operation	12
Manual Watering by Zone	12
Manual Watering by Start	13
Starts	14
Additional Information	17
Device Information	17
Remove Device	17
Troubleshooting	18
EVIE (Evaporative Intelligent Eco Rain Sensor)	18
Pairing WX8 to EVIE Sensor	18
Unable to Restore After an Outage	21
To Reconnect	21
Resources	22
Warranty	23



PRODUCT CODE: WX8

Customer Service

support@holmanindustries.com.au
www.holmanindustries.com.au

RWC Reliance Worldwide
Corporation (Aust.) Pty. Ltd.

27-28 Chapman Place
Eagle Farm, QLD, Australia 4009

iOS is a trademark of Apple Inc. Android is a trademark of Google LLC. The Android robot is reproduced or modified from work created and shared by Google and used according to terms described in the Creative Commons 3.0 Attribution License. All other content is Copyright © Holman Industries 2024

Introduction

The **WX8 Wi-Fi Irrigation Controller** allows anyone with a smartphone and Wi-Fi access to control their irrigation from anywhere on the globe. Each solenoid is connected to your **WX8** via a cable. To water a **ZONE**, the **WX8** sends an electric current to the solenoid coil. After the **RUN TIME** has expired, the electric current is discontinued and the valve closes. The **WX8** then automatically opens the next valve in the sequence, until all **ZONES** have been watered. For more information on the **WX8 Wi-Fi Irrigation Controller**, visit www.holmanindustries.com.au/wx8-wifi-irrigation-controller

⚠ Please read these instructions in full before proceeding with setup

i Some screens in this guide may differ slightly depending on your mobile device and **Holman Home** app version



Key Features

- ⊗ 8 watering **ZONES**
- ⊗ 3 **START TIMES** where **ZONES** can be allocated to each **START**. In addition, **Holman Home** provides the ability to setup **TAP-TO-RUN** watering scenes and **AUTOMATION** watering scenes for your **STARTS** and **ZONES**
- ⊗ 7-day watering schedule
- ⊗ Permanent memory
- ⊗ Real time clock
- ⊗ **POWER SUPPLY:**
This unit runs off a 240V 50/60Hz single phase outlet, drawing 30VA at 240V AC
- ⊗ Weatherproof outdoor housing with lid
- ⊗ No electrician required for installation
- ⊗ Compatible with master valve or pump relay
- ⊗ Rain sensor capable input
- ⊗ Compatible with **EVIE Sensor** (sold separately)
- ⊗ Manual operations:
SYSTEM TEST, SINGLE ZONE
or **MANUAL START; A, B or C**
- ⊗ Smartphone operation
- ⊗ 2.4GHz Wi-Fi compatible

Mobile Device System Requirements

Android 4.4.2 and above or,
 iOS 12.0 and above



Wi-Fi Control with HOLMAN Home

- ✓ **2.4GHz Wi-Fi Connection** via your smartphone with Holman Home
- ✓ **Voice command enabled** with Amazon Alexa and Google Assistant

SCAN FOR MORE INFO

Download on the **App Store**

GET IT ON **Google Play**



Overview

Third Party Rain Sensors

⊗ This is to detect rainfall and automatically suspend watering, resuming after the sensor dries out

⊗ Remove the link connector between **C** and **R**, and replace with 2 wires from your rain sensor as shown below

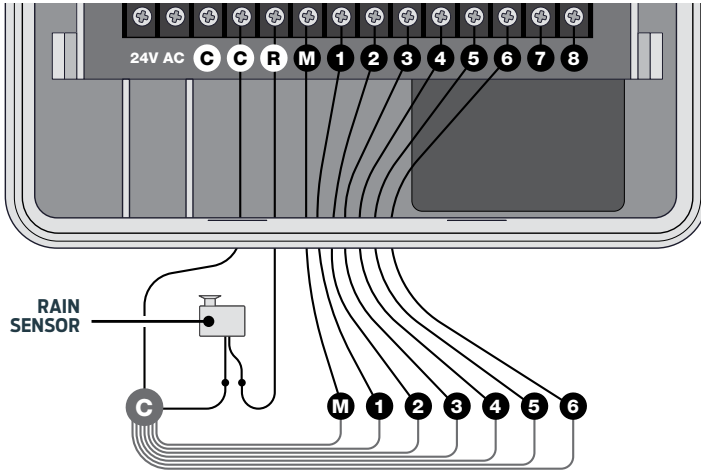

⊗ In this installation the common is not cut - but used as a shared terminal for the rain sensor and your existing common wire

⊗ Rain sensors can also be installed where one rain sensor wire is on the common terminal, the other wire connects to the shared station common wire:

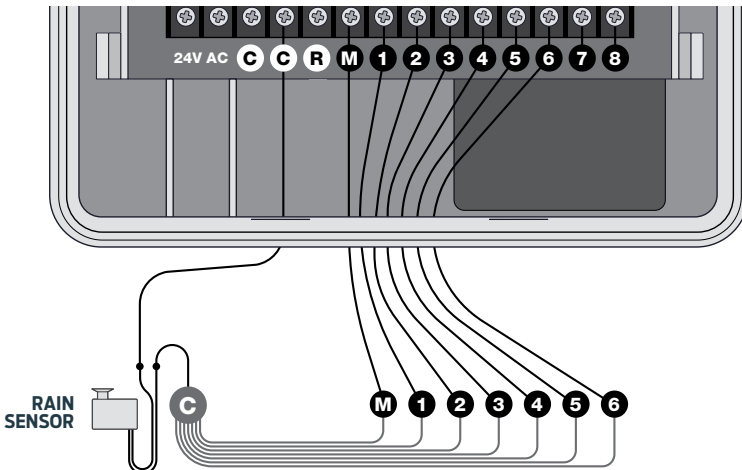

Overview (continued)

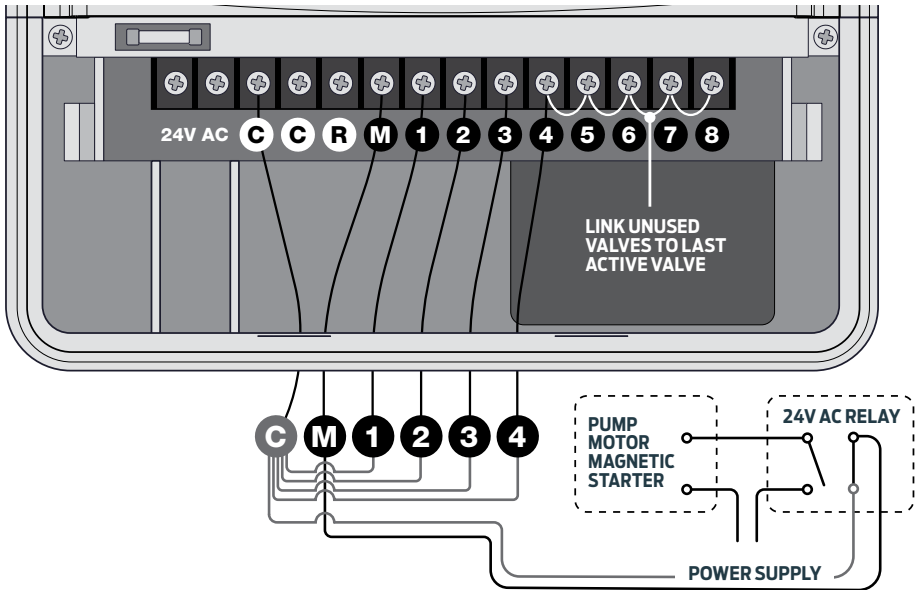

Pump Connection

- i** Your **WX8** doesn't provide mains power to drive a pump. It does provide a low voltage signal to actuate a relay, enabling the contactor and the pump
- i** Do not attempt to drive a pump starter directly from the controller
- ⊗** Pump start is provided by connecting one side of the coil from a suitable relay to the **MASTER VALVE/PUMP START (M)** output of the controller and the other side to the controller common
- i** Unused stations must be connected back to the last used station to prevent running against a closed head if run times are incorrectly set



Setup

Initial Setup

1. Download **Holman Home** to your mobile device via the  **App Store** or  **Google Play**
2. Open **Holman Home** on your mobile device
 -  You may be prompted to allow notifications—the app can still function if you choose to opt out
3. Tap **SIGN UP**
4. Read our User Agreement and Privacy Policy and tap **AGREE** if you wish to proceed
5. Follow the prompts to register a **Holman Home** account with your email address

 **Ensure your country details are correct at this stage**

 You may be prompted to allow access your location. This allows the app to show weather information—it will still function if you choose to opt out



Control your garden from anywhere in the world, day or night, with *Holman Home* Wi-Fi control. Enjoy complete control of your irrigation and garden lighting, wherever internet access is available.



Setup (continued)

Pairing Using EZ Mode

1. The Home Screen should now appear and you should be able to add devices to your **Holman Home** by tapping **ADD DEVICE** or **+**
2. To find the **WX8 Irrigation Controller**, tap **GARDEN WATERING**
3. Then tap the **WX8** icon to start searching for your **Irrigation Controller**
4. This begins the Wi-Fi pairing process with your **WX8**. Follow the prompts on your mobile device to complete the pairing process

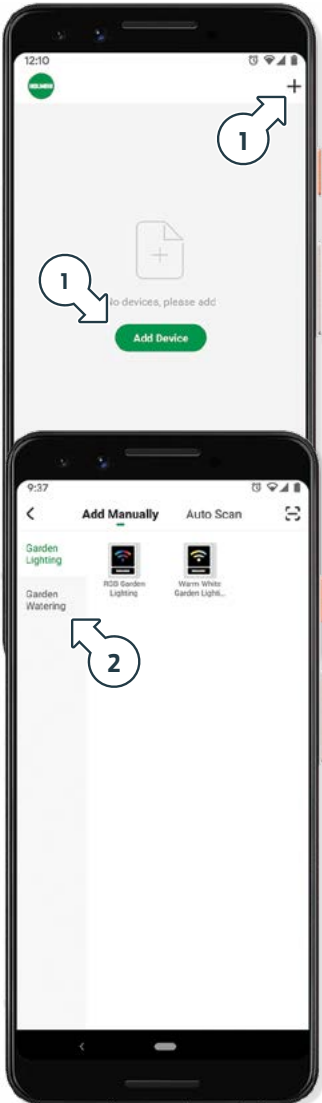

Setup (continued)

Pairing Using AP Mode

AP mode can help where you have more than 1 network name, or use a guest network. We recommend this for mesh systems and Wi-Fi 6 modems.

Before You Start:

- ⊗ Turn off mobile data
- ⊗ Turn off 'auto join/auto reconnect on your 5GHz network
- ⊗ Connect your device to your 2.4GHz network
- ⊗ Turn the dial on your **WX8** to the AP position
- ⊗ Press and hold the **START** button on the **WX8** for 5 seconds, the AP light should now flash red slowly

1. Tap **ADD DEVICE** or **+** in your **Holman Home** app

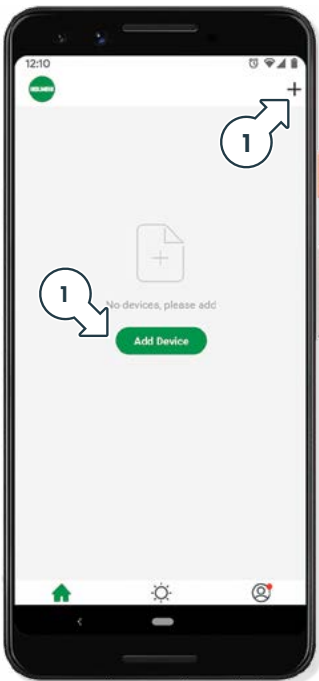

2. To find the **WX8 Irrigation Controller**, tap Garden Watering
3. Then tap the **WX8** icon to start pairing
4. Enter your Wi-Fi information, select next

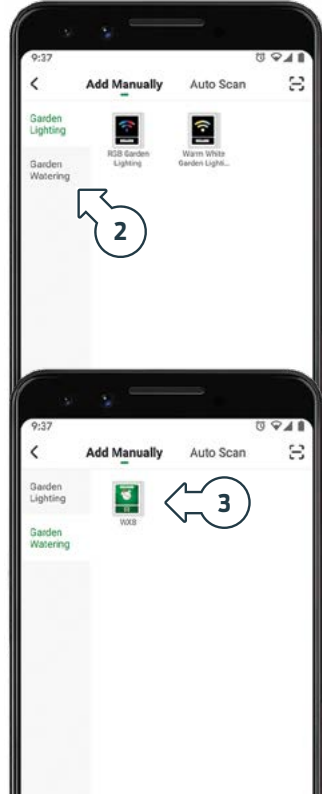

Setup (continued)

Pairing Using AP Mode (continued)

5. Tap EZ mode at the top of the screen
6. Select AP mode from dropdown menu
7. Confirm the slow flash
8. Connect (join) to the **WX8** hot spot and follow the in-app prompts to complete pairing



Setup (continued)

Status Screen

1. After completing the Wi-Fi pairing process, your **WX8** will be available on the **Holman Home** device screen. Tap this for advanced watering controls

The **STATUS** screen shows:

- a. The current controller state - watering or not watering, you can press **STOP** during a watering to stop the program
 - b. Whether **STARTS** are enabled or disabled
 - c. The battery status (9V back up memory)
 - d. Dial Position
- i** If the dial is in the OFF position this will disable the **STARTS**. The Dial Position text will be red [e]
 - i** If the dial is in the AP position, the Dial Position text will be red with an alert.
 - i** It is best practice to have the dial either on RUN or OFF
 - i** Install a **9V BATTERY** to clear the battery message

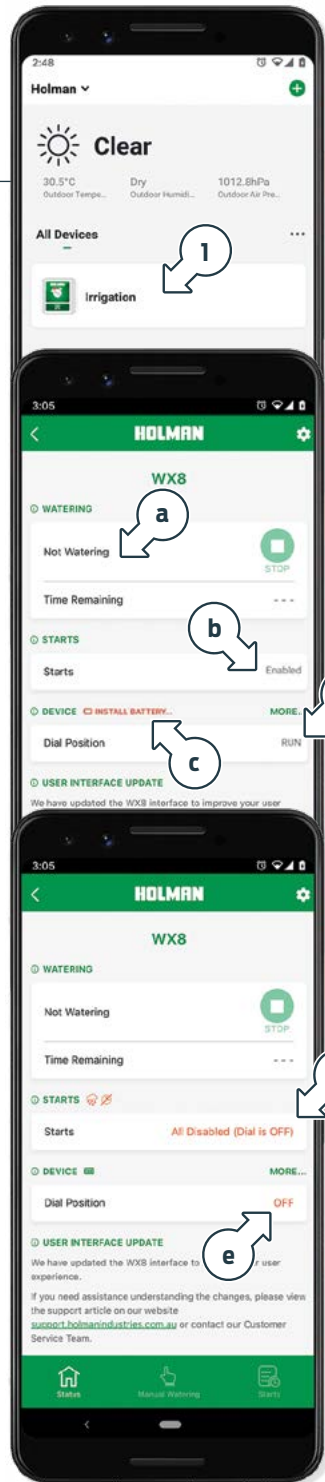

Setup (continued)

Status Screen (continued)

2. Tap **MORE...** for detailed **DEVICE INFORMATION**
 - f. On the **DEVICE INFORMATION** page the status of the rain sensor and rain sensor type (hard wired or EVIE) can be viewed
 - g. If you are not using a hard wired rain sensor, but your hard wired rain sensor is reporting as wet, you may have accidentally removed the bridge. This will stop watering —return the bridge to correct this

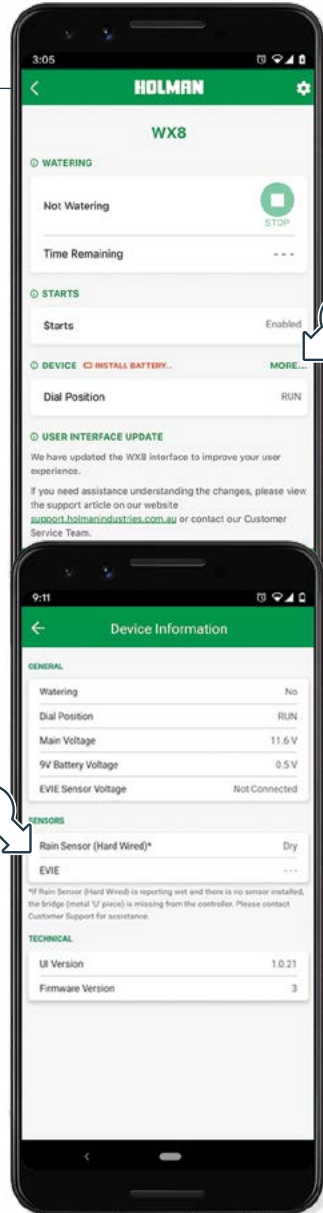

Operation

Manual Watering by Zone

1. Tap **MANUAL WATERING** to access **MANUAL WATERING** by **ZONE** or **START**
2. Select a **ZONE** to water
3. Tap beside the **ZONE** name to open the **MANUAL WATERING** time selector



4. Scroll up and down to select the manual run time
5. Press **SAVE** to update
6. Tap ▶ to start watering

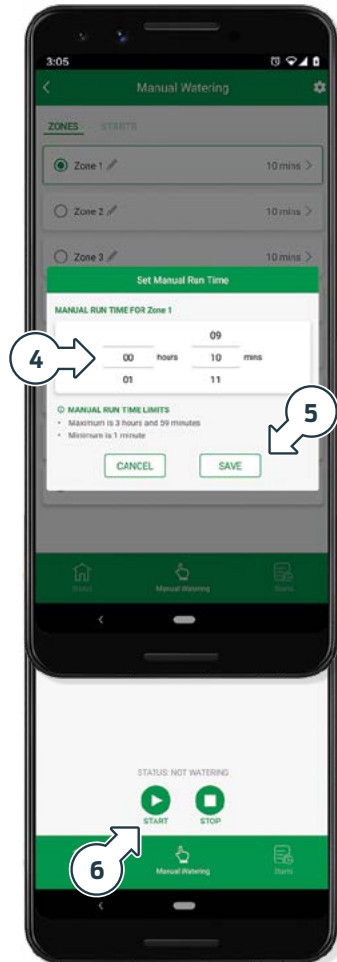

Operation (continued)

Manual Watering by Start

1. Tap **MANUAL WATERING** to access **MANUAL WATERING** by **ZONE** or **START**
2. Tap **STARTS** to see start options for the use of your program manually
3. Select the **START** you wish to run (**START A, B or C**)
4. Tap ► to start the program

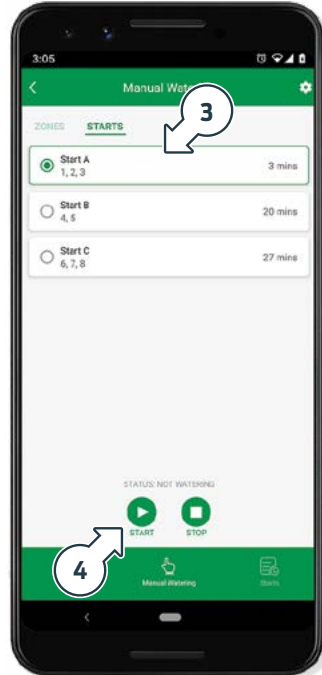
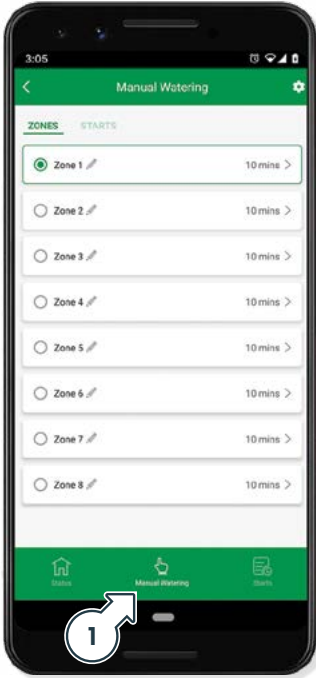

Operation (continued)

Starts

1. Tap **STARTS** to access program settings
2. Tap a **START (START A, B or C)** to enter the program settings
3. Enable the **START**
4. Tap the **START TIME** line to set the start time.
5. Select the time by scrolling up and down the screen. Tap OK to confirm

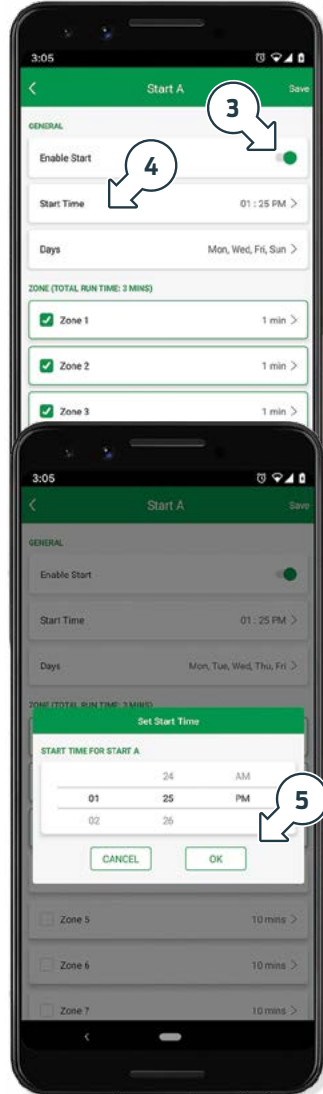
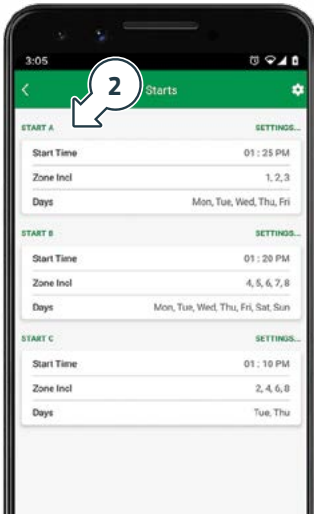
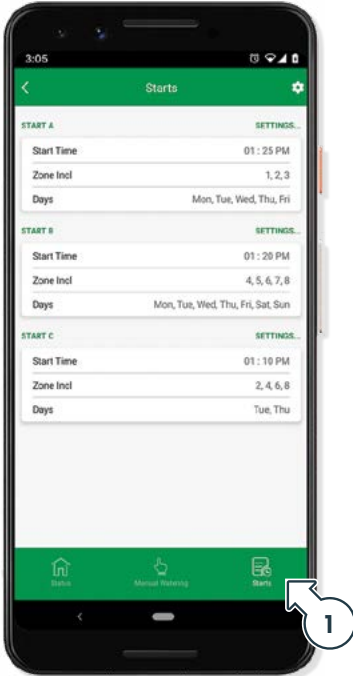

Operation (continued)

Starts (continued)

6. Tap the Days line to set watering days
7. Select your watering days (green days are on, white days are off), and then tap Next

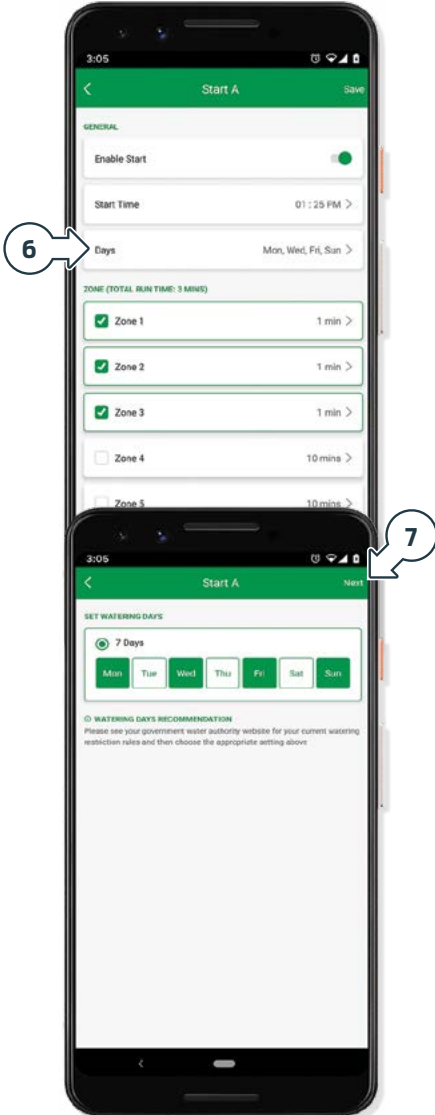

8. To add a **ZONE** to the **START**, tap the **ZONE CHECKBOX** to select it, then tap beside the **ZONE** name to open the Set Run Time window
9. Scroll your finger up and down to select the time, tap OK to confirm
10. Repeat for each **ZONE** in the **START**.

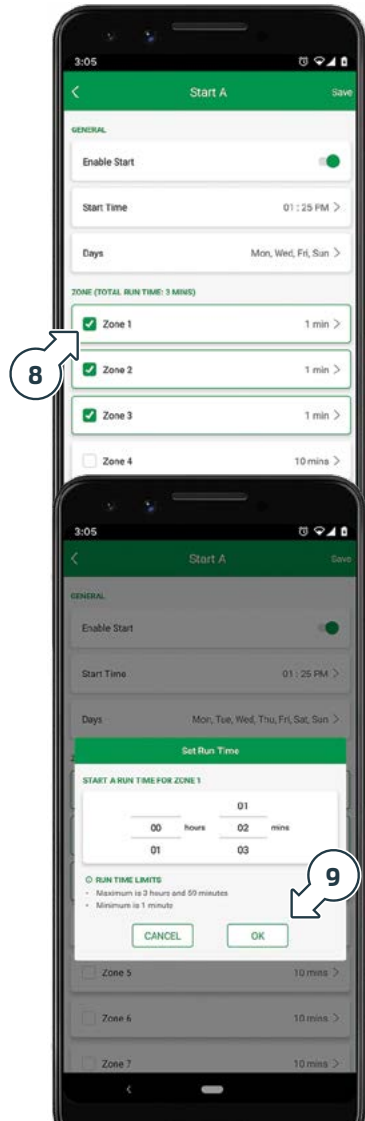

Operation (continued)

Starts (continued)

11. Tap **SAVE** to update the **WXB** with this schedule.
12. To set **STARTS B** and **C**, follow steps 2-11 again

i If any part of the **START** has been changed, but not saved, a warning screen will pop up. You can choose to **SAVE** or **DISCARD** your changes.

i Example of all **STARTS** being used

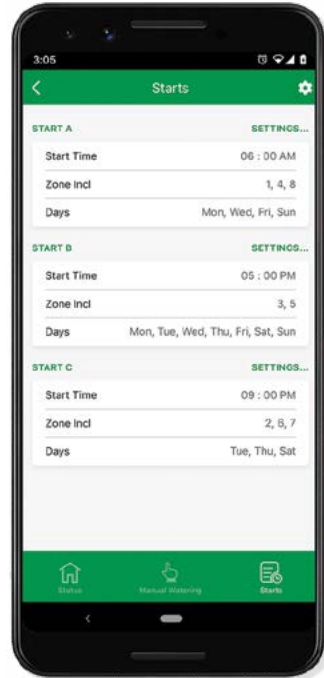
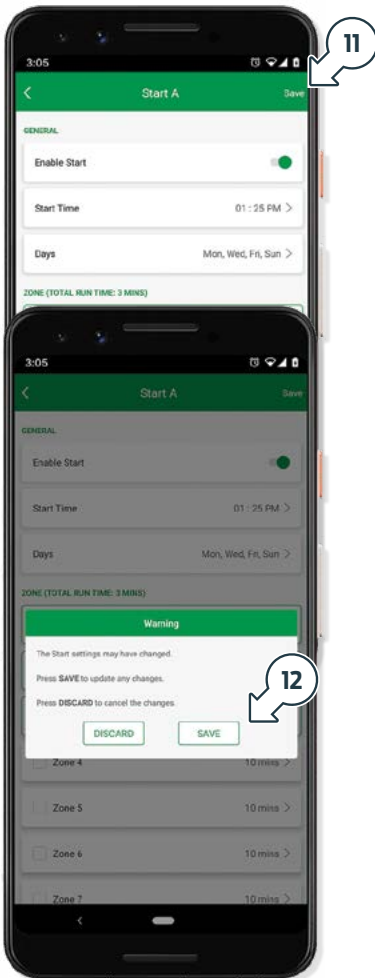

Additional Information

Device Information

1. Tap the cog at the top right of the page to access additional information
2. **THIRD PARTY CONTROL**—Information on **GOOGLE** and **ALEXA** set up.
3. **DEVICE INFORMATION**—Includes:
 - Virtual ID (for technical support)
 - IP address
 - MAC
 - Time zone of the device
 - Device signal strength
4. **TAP-TO-RUN AND AUTOMATION**—short cut to view tap to run previously set for your **WX8** via scene automation.
5. **CREATE GROUP**—N/A for this device
6. **CHECK DEVICE NETWORK**—additional diagnostic tool when Wi-Fi is weak.
7. **SHARE DEVICE**—share the **WX8** with another **Holman Home** user.
8. **OFFLINE NOTIFICATION**—toggle on to get a notification when the device has been offline for over 30min.
9. **HELP CENTER**—In app hints, tips and instructions. Automation suggestions are available here.

Remove Device

10. **REMOVE DEVICE** - tap here to remove the **WX8** from your **Holman Home** app.
11. **DISCONNECT** to reconnect with your settings intact
12. **DISCONNECT AND WIPE DATA** - restore to factory default.

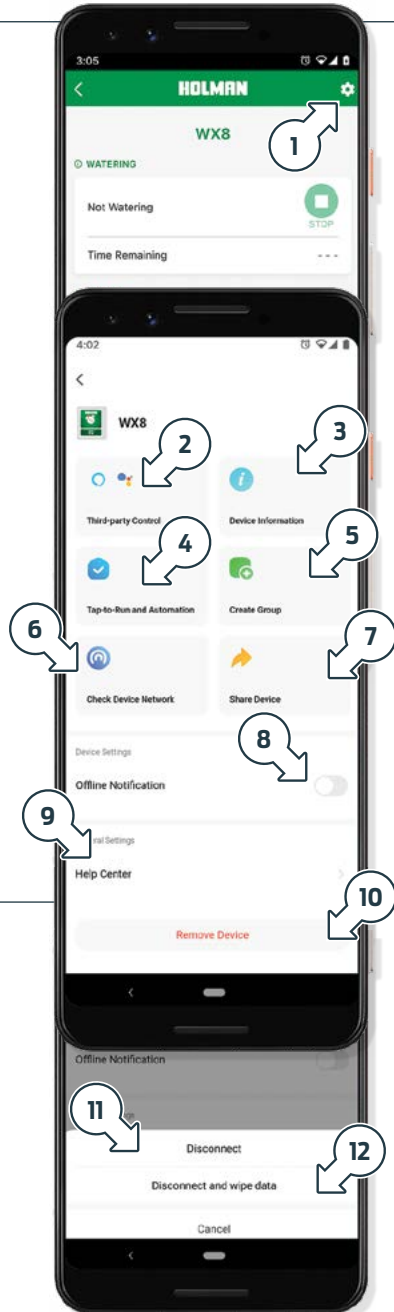

Rain Sensor

EVIE (Evaporative Intelligent Eco Rain Sensor)

Your **WX8** is compatible with our **EVIE Sensor**. Refer to the sensor manual for setup help. **EVIE Sensor** will already be connected if it was included with your **WX8** package

1. EVIE will report as wet using a red cloud indicator on the **STATUS** page. In this example EVIE is reporting as wet.

STARTS are disabled during this time. Please refer to the in app Help Centre for EVIE work arounds (i.e. patio watering)

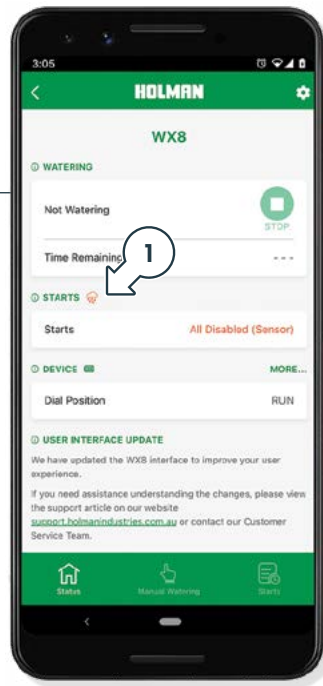

Pairing WX8 to EVIE Sensor

If for some reason the **EVIE Sensor** has been disconnected from your **WX8, Holman Home** will show this in the **DEVICE INFORMATION** screen [a].

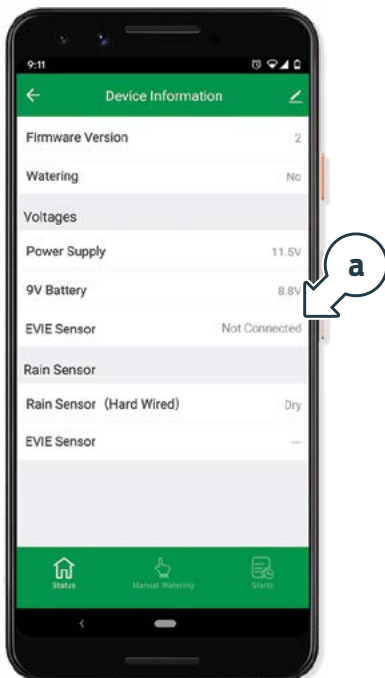

The following instructions highlight how to re-pair your **EVIE Sensor** to the **WX8**:

1. Bring your **EVIE Sensor** to your **WX8 Irrigation Controller** so that you can operate both devices simultaneously
2. On the **EVIE Sensor**, unscrew the lid [b] to open and check there are two CR2032 batteries [c] installed

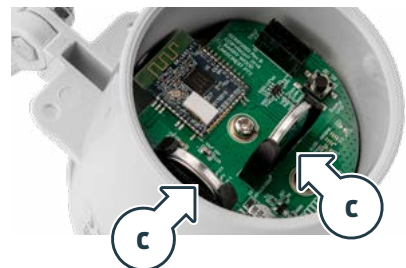
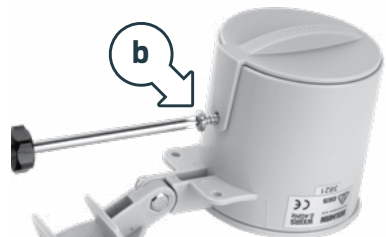

Rain Sensor (continued)

Pairing WX8 to EVIE Sensor (continued)

- On your **WX8**, turn the dial to **OFF**
- Press and hold **START** for 5 seconds until the LEDs of **ZONE 1** and **2** both flash, alternating between red and blue (for 20 seconds only)
 - The next step must be completed in the first 20 seconds while the LEDs are still flashing
 - If you run out of time it is possible to attempt the process again
- On the **EVIE Sensor**, press and hold the internal button [d] until the **WX8** LEDs of **ZONE 3** and **4** are alight
 - If the pairing succeeds, these LEDs will be blue
 - If the pairing fails, these LEDs will be red
- After pairing is successful, on the **WX8**, turn the dial to **RUN** to exit the pairing mode
- Wait at least one minute for the **Holman Home** to show **EVIE Sensor** is connected to the **WX8** in the **DEVICE INFORMATION** screen [e]
- Follow the instructions for **CHECKING YOUR EVIE SENSOR** as listed overleaf
- Re-install your **EVIE Sensor** as per the **INSTALLATION** instructions overleaf
 - For additional pairing help, please visit <https://www.holmanindustries.com.au/> to access additional support pages or contact our Customer Service team
 - Please visit the following for additional support:
<https://www.holmanindustries.com.au/product/wx8-wifi-irrigation-controller-with-evie-sensor>

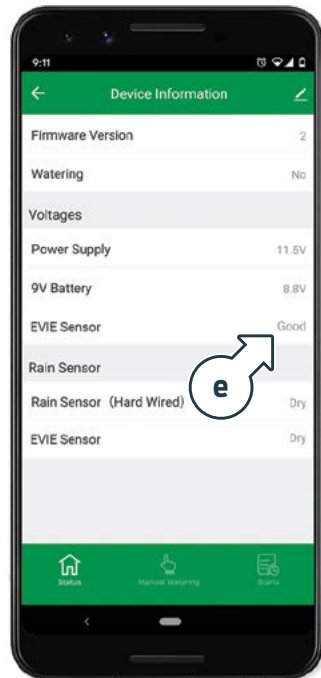

<https://www.holmanindustries.com.au/product/evie-evaporative-intelligent-eco-rain-sensor/>

Troubleshooting

Unable to Restore After an Outage

After an extended outage (either power or internet) your device may have been unable to reconnect (self restore). If it is offline in **Holman Home**, then it needs to be physically checked.

Please check the AP light on your controller:

- ⊗ If the AP light is blue then your **WX8** is ok.
- ⊗ If the AP light is red this means your **WX8** has become disconnected.
- ⊗ If the AP light is purple/pink this means your **WX8** is having hardware issues, it may come back into pairing mode, but it may not - please attempt reconnection.

Please be assured while disconnected your **WX8** would still be running any **STARTS** you have set and would be able to manually water with no issue, but any Smart scenarios you have setup would not be working. Also any changes you have made via the **Holman Home** app since the outage will not have saved.





To get your **WX8** connected again it will need to be removed from the app and re-added. After doing this process you will need to review any Smart scenarios you have setup and you will need to rename any changed **ZONE** names. Any **STARTS** already setup should be remembered when the **WX8** is re-added.

To Reconnect After an Outage

1. On the **WX8** move the MAIN DIAL to the AP position and then press **START**
2. The AP light should now be flashing red quickly
3. In the **Holman Home** app choose the **WX8** and then tap the pencil icon (top right). At the bottom of this screen choose **REMOVE DEVICE**, then *Disconnect
- ⓘ If you accidentally press Disconnect and wipe data then you will reset your **WX8** and lose all settings. It will be like setting up your **WX8** from new
4. From the Home Screen press **+**
5. Choose Garden Watering on the left side and then the **WX8**
6. Follow the instructions on the app to re-add the device
7. Once your **WX8** has been re-added the AP light should be blue. On the **WX8** remember to move the MAIN DIAL to the RUN position
8. If you're having any issue getting into AP mode, or the light is stuck in purple/pink please contact us for further assistance.

Troubleshooting (continued)

General FAQs

Symptom	Suggestion
WX8 cannot connect to Holman Home	<p>When adding your WX8 to Holman Home:</p> <ol style="list-style-type: none"> 1. Confirm your WX8 is powered ON 2. Confirm  AP on your WX8 is flashing RED 3. Confirm both your WX8 and smartphone are within Wi-Fi range 4. Make sure the network functions of your Wi-Fi router and smartphone are unblocked; firewalls can block certain ports 5. Confirm your Wi-Fi network name (SSID) has been entered correctly, including spaces. Note this is case sensitive 6. Confirm your Wi-Fi network password has been entered correctly 7. Confirm your WX8 is connected to a 2.4GHz Wi-Fi network (not 5GHz), enable the broadcast and do not allow the Wi-Fi network to be hidden 8. Confirm your Wi-Fi router encryption method is WPA2-PSK and authentication type is AES, or both are set to automatic. 9. If the number of connected devices to the Wi-Fi has reached the amount limit (usually 16 to 50 devices), turn off other Wi-Fi devices and configure again 10. If your Wi-Fi router enables the MAC address filter, remove the device from MAC filter list and make sure the Wi-Fi router is allowing your WX8 to be connected 11. Make sure that the Wi-Fi router has the DHCP service enabled. If it is not enabled, the address will be occupied. 12. If your modem features Wi-Fi 6, or you are using a mesh network, set up a 2.4GHz guest network for connection.
WX8 was connected but  AP is now RED or OFF after mounting in desired position	This indicates a lack of Wi-Fi signal. You will need to move your WX8 and Wi-Fi router closer to each other
 AP LED is OFF	Your WX8 cannot connect; check your Wi-Fi router
 AP LED is RED	Your WX8 cannot connect to the cloud server; check your internet connection as you will not be able to control watering with Holman Home
No LED lights on	No AC power, or a blown fuse or transformer. Check fuse and transformer output. Turn power on
Single zone not working	Faulty solenoid coil, or break in field wire. Check solenoid coil (a good solenoid coil should read around 33 Ω on a multi meter). Test field cable for continuity. Test common cable for continuity
No automatic start	Setup error, rain sensor is wet, MAIN DIAL is in OFF position, or blown fuse or transformer. If unit works manually then check the setup, rain sensor status or MAIN DIAL position. If not then check the fuse, wiring and transformer is supplying 24V AC (measured on a multimeter)
Buttons not responding	Please contact our Customer Service team
Multiple zones watering at once	Possible faulty driver triac, incorrect field wiring or broken or lost common wire in field. Check wiring and swap faulty valve wires on the controller terminal block with known working ZONES . If the same outputs are still locked on, please contact our Customer Service team
Pump start relay chattering	Faulty relay or pump contactor. Find an electrician to check voltage on relay or contactor
Rain sensor not working	<p>For third party sensors, this could be faulty wiring or sensor. Check rain sensor information on Holman Home and check the wiring on sensor. For our EVIE Sensor, refer to the sensor manual provided for troubleshooting</p> <p>If the EVIE Rain Sensor battery run flat while wet, the WX8 will be locked in wet mode, disabling STARTS. EVIE must be fitted with new batteries, and read dry, to resume watering.</p>
Test function not working	Test function will not work unless appropriate ZONES have RUN times allocated to STARTS A, B or C in Holman Home

Resources

For additional resources, please visit

www.holmanindustries.com.au/wx8-wifi-irrigation-controller

- ⚠ Your **WX8** is designed to be operated via your device with the **Holman Home** app. Without this, your **WX8** will have limited functions
- ℹ Always ensure you are running the latest version of **Holman Home** on your device to avoid limiting its functions
- ℹ Additional resources are also available via the in app Help Centre. These can help with creating automations for your **WX8**. Automations can be used to water when a rain sensor is 'wet', or to create 'Tap-to-Run' short cuts. Data from **Holman Home** weather stations can be also used for automations.
- ℹ Automations rely on a consistent Wi-Fi signal strength of at least -70dBm (ideally -60dBm) - when signal is weak (-80dBm or lower) or intermittent automations may not work as expected.

Warranty

3 Year Replacement Guarantee

Holman offers a 3 year replacement guarantee with this product.

In Australia our goods come with guarantees that cannot be excluded under the Australian Consumer Law. You are entitled to a replacement or refund for a major failure and compensation for any other reasonably foreseeable loss or damage. You are also entitled to have the goods repaired or replaced if the goods fail to be of acceptable quality and the failure does not amount to a major failure.

As well as your statutory rights referred to above and any other rights and remedies you have under any other laws relating to your Holman product, we also provide you with a Holman guarantee.

Holman guarantees this product against defects caused by faulty workmanship and materials for 3 years domestic use from the date of purchase. During this guarantee period Holman will replace any defective product. Packaging and instructions may not be replaced unless faulty.

In the event of a product being replaced during the guarantee period, the guarantee on the replacement product will expire 3 years from the purchase date of the original product, not 3 years from the date of replacement.

To the extent permitted by law, this Holman Replacement Guarantee excludes liability for consequential loss or any other loss or damage caused to property of persons arising from any cause whatsoever. It also excludes defects caused by the product not being used in accordance with instructions, accidental damage, misuse, or being tampered with by unauthorised persons, excludes normal wear and tear and does not cover the cost of claiming under the warranty or transporting the goods to and from the place of purchase.

Should you suspect your product may be defective and need some clarification or advice please contact us directly:

1300 716 188

services@holmanindustries.com.au

11 Walters Drive, Osborne Park 6017 WA

If you are certain your product is defective and is covered by the terms of this warranty, you will need to present your defective product and your purchase receipt as proof of purchase to the place you purchased it from, where the retailer will replace the product for you on our behalf.



**Thanks for being a
#SMARTGARDENER**



**We really appreciate having you as a customer,
and would like to say thank you for choosing us.**

We recommend registering your new product on our website. This will ensure we have a copy of your purchase and activate an extended warranty. Keep up to date to with relevant product information and special offers available through our newsletter.

www.holmanindustries.com.au/product-registration/



HOLMAN

For the #SMARTGARDENER   

Copyright © 2024 Holman Industries